

PHAROS A3

A S



mm	5250x41
m/f	15 - 120
kW	5,5
Kg	4200



0°	
mm	360
mm	360
mm	H360x360
A	3250
B	2200
C	2350

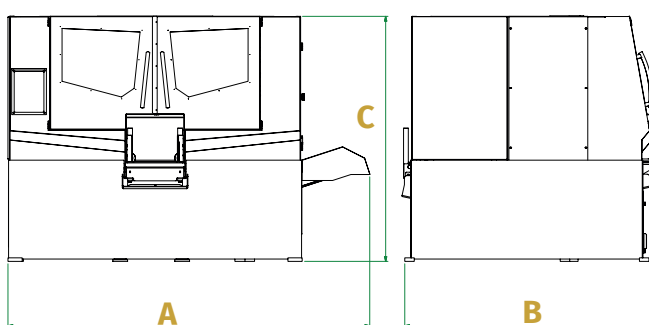

PHAROS A5

A S



mm	7450x54
m/f	15 - 120
kW	7,5
Kg	5800



0°	
mm	530
mm	530
mm	H530x530
A	4800
B	2350
C	2850

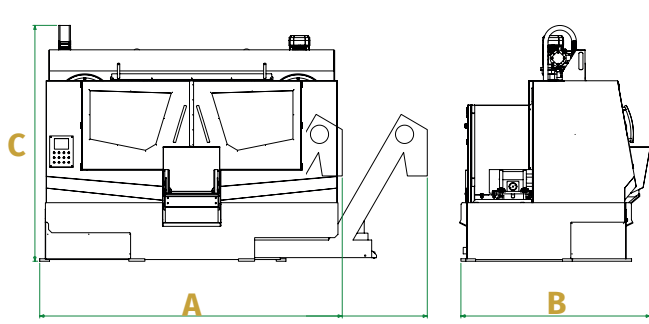

PHAROS A4

A S



mm	6400x54
m/f	15 - 120
kW	7,5
Kg	5200



0°	
mm	440
mm	440
mm	H440x440
A	4250
B	2200
C	2350

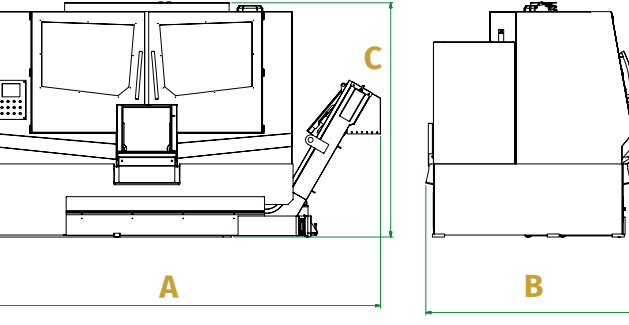

PHAROS A6

A S



mm	8450x67
m/f	15 - 120
kW	11
Kg	7500



0°	
mm	630
mm	630
mm	H630x630
A	5050
B	2200
C	3220

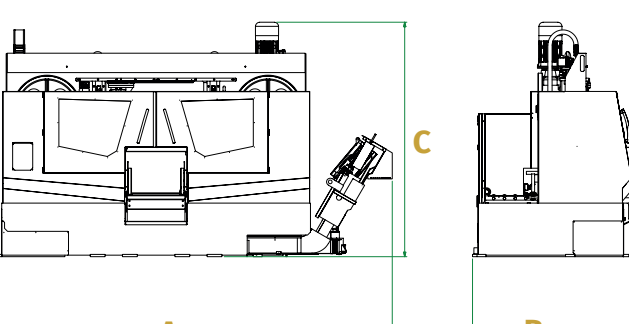

VBS 400

M S



mm	3150x3-16
m/f	20 - 1000
kW	1,5
Kg	435



0°	
mm	395x255

A	940
B	675
C	1840

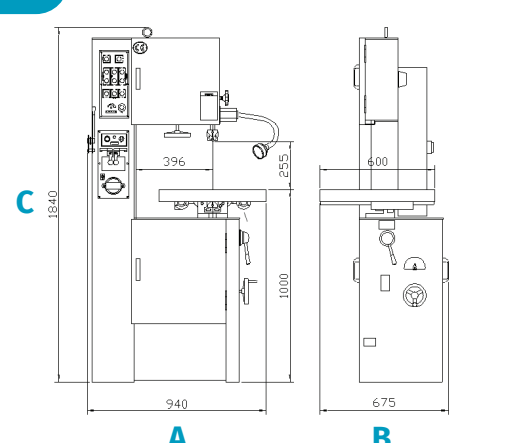

VBS 600

M S



mm	4710x3-27
m/f	15-1500
kW	2,2
Kg	680



0°	
mm	650x360

A	1340
B	810
C	2190

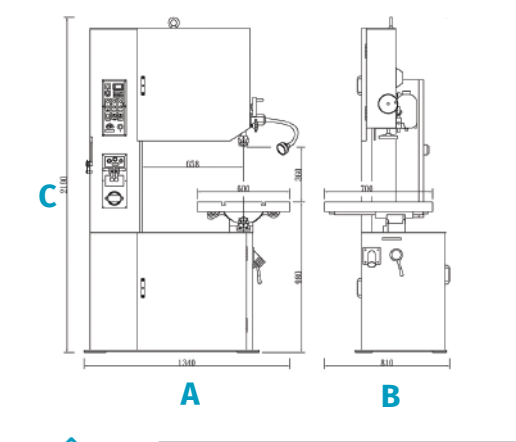

VBS 900

M S



mm	5030x3-27
m/f	15-1500
kW	2,2
Kg	815



0°	
mm	910x330

A	1760
B	810
C	2060

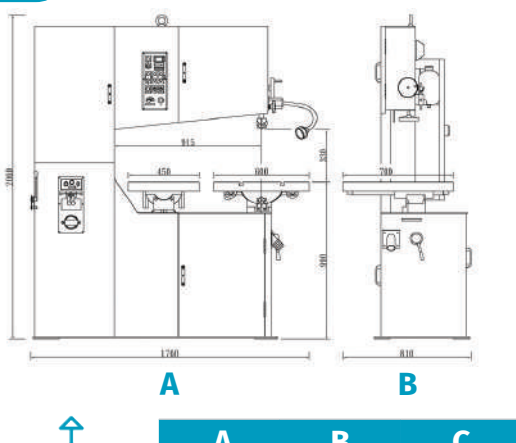

KlaeGER Sägetechnik GmbH
Tulpenstrasse 52
D-71394 Kernen
www.klaeGER.com

+49 (0) 7151/369030
+49 (0) 7151/3690310
+49 (0) 7151/3690311
+49 (0) 7151/3690312

info@klaeGER.com
verkauf@klaeGER.com
support@klaeGER.com
service@klaeGER.com

KLAEGER

SÄGETECHNIK



GESAMT PROGRAMM GENERAL CATALOGUE	Manuell Manual/Gravitational	Halbautomatisch Semi-automatic	Automatisch Automatic
Horizontale Säge Horizontal Cut	M/G	S	A
Vertikale Säge Vertical Cut	M	S	A
Additive Fertigung 3D Säge Additive manufacturing 3D Cut		S	

PHAROS K2

A S



mm	3200x27x0,9
m/f	20 - 100
kW	2,2
Kg	1060



0°	
mm	300
mm	300

A	1716
B	3055
C	1995

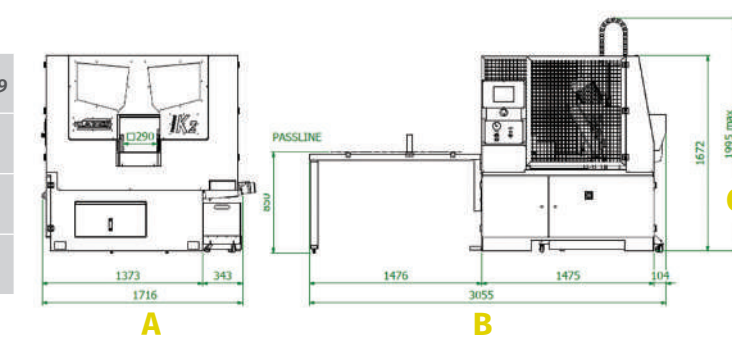

PHAROS K3

A S



mm	3920x34x1,1
m/f	20 - 100
kW	4,0
Kg	2200



0°	
mm	300
mm	300

A	2100
B	2173
C	1845

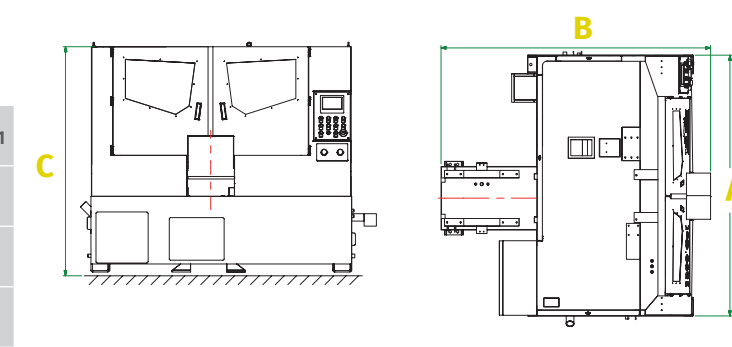

PHAROS K4

A S



mm	4880x41x1,3
m/f	20 - 100
kW	5,5
Kg	3000



0°	
mm	420
mm	420

A	2962
B	2320
C	2032

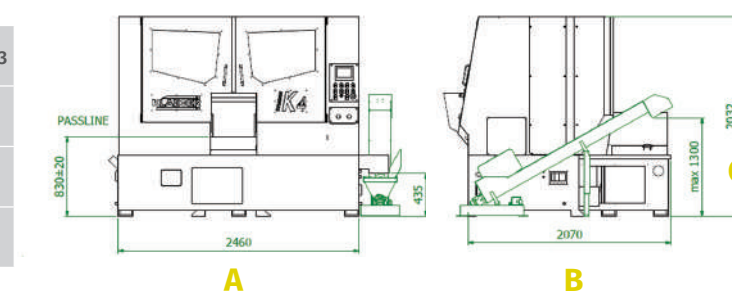

HBS 255 DG M/G

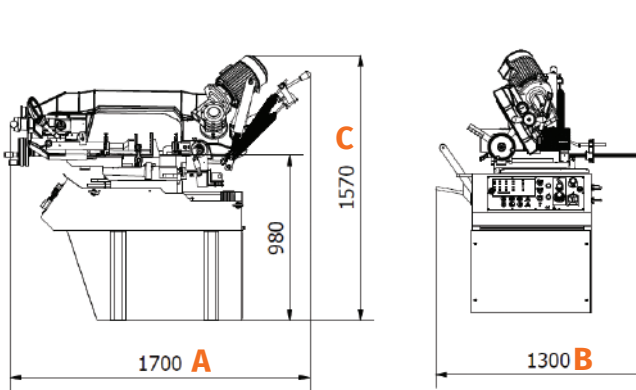

mm	2750x27x0,9
m³/min	20 - 80
kW	1,5
kg	430

°	0°	45°	60°	-45°
mm	255	185	115	180
mm	255	180	115	170
mm	H160x310	H230x170	H160x115	H220x140

A	B	C
1700	1300	1570

ACTRON 355 DG S M/G

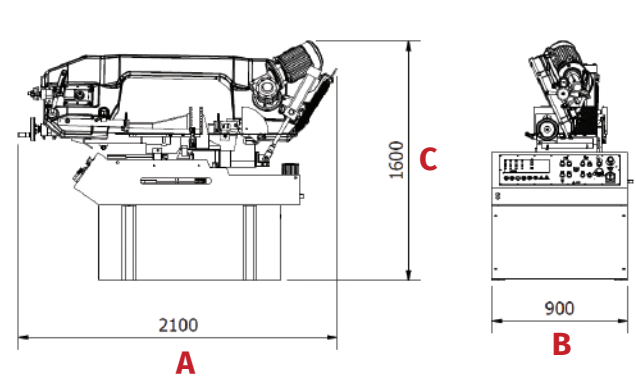

mm	3770x34x1,1
m³/min	20 - 80
kW	2,2
kg	720

°	0°	45°	60°	-45°
mm	355	355	230	290
mm	280	280	180	250
mm	H280x490	H280x340	H180x220	H250x250

A	B	C
2100	900	1600

BITRON K2 S



mm	3200x27
m³/min	20 - 90
kW	2,2
kg	600

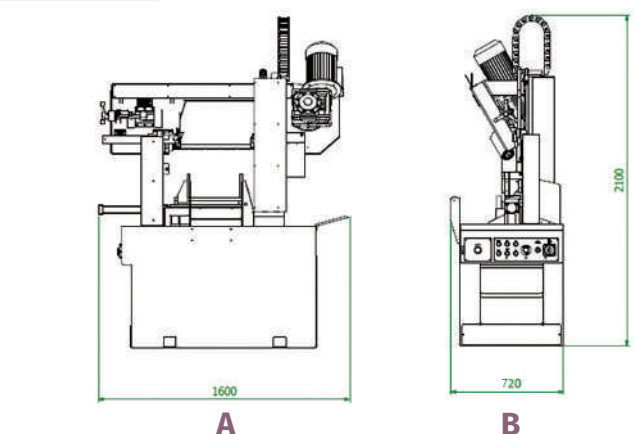



°	0°
mm	300
mm	300
mm	H300x300

A	B	C
1600	720	2100

FORTUNA 300 G-ÖKO A S

MANUELLE GERUNG

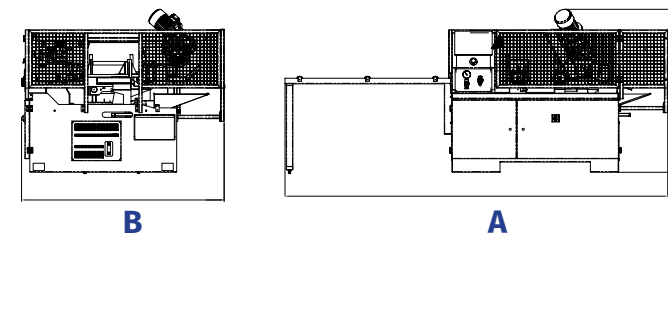

mm	3200x27
m³/min	20 - 90
kW	2,2
kg	960

°	0°	45°	60°
mm	300	265	130
mm	290	265	130
mm	H290x300	H220x220	H130x130

A	B	C
3400	2050	1820

HBS 355 DG M/G

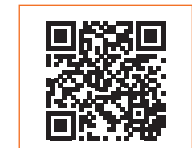
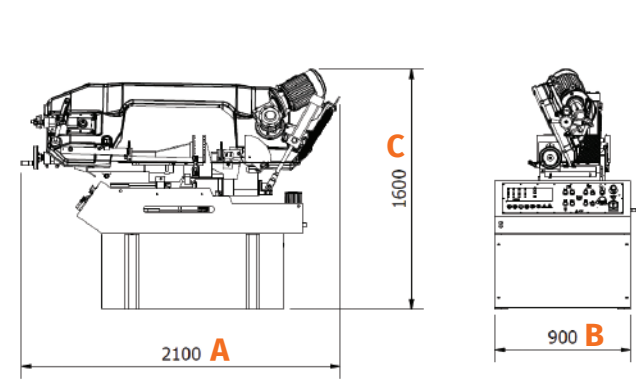

mm	3770x34x1,1
m³/min	20 - 80
kW	2,2
kg	630

°	0°	45°	60°	-45°
mm	355	355	230	290
mm	280	280	180	250
mm	H280x490	H280x340	H180x220	H250x250

A	B	C
2100	900	1600

ACTRON 400 DG S

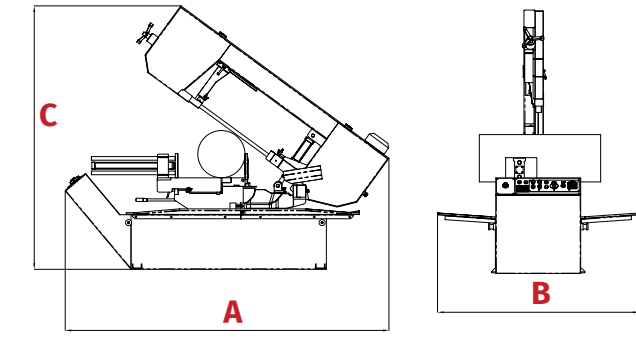

mm	4610x34x1,1
m³/min	20 - 80
kW	2,2
kg	820

°	0°	45°	60°	-45°	-60°
mm	400	400	260	400	280
mm	400	380	260	380	280
mm	H400x550	H300x410	H400x230	H300x420	H400x280

A	B	C
2900	800	2300

BITRON K2G S



mm	3200x27
m³/min	20 - 90
kW	2,2
kg	650

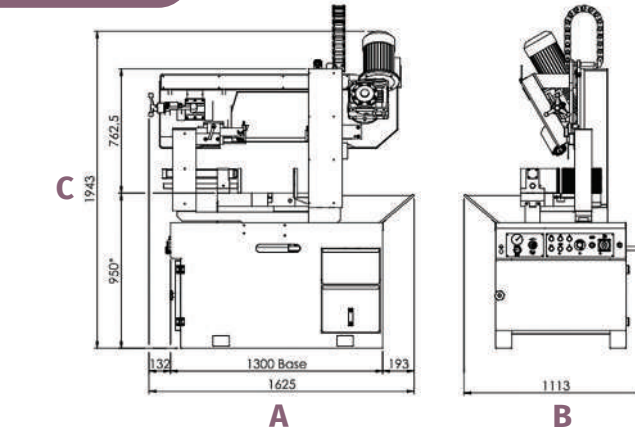



°	0°	45°	60°
mm	300	220	130
mm	280	210	130
mm	H280x300	H210x210	H130x130

A	B	C
1625	1110	2100

FORTUNA: 300 DG / 300 AUTO DG A S

MANUELLE 2x GERUNG / AUTOMATISCHE 2x GERUNG

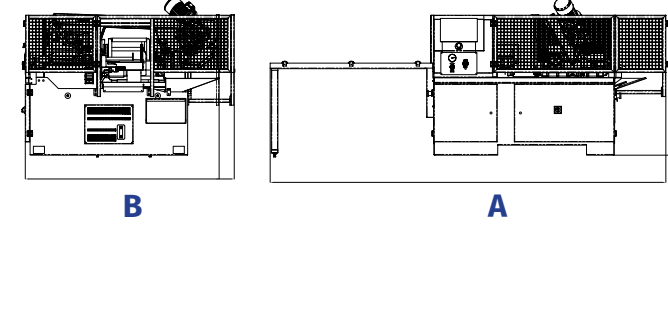

mm	3200x27
m³/min	20 - 90
kW	2,2
kg	960

°	0°	45°	60°	45°
mm	300	240	140	180
mm	280	220	140	180
mm	H280x300	H130x240	H140x140	H110x180

A	B	C
3400	2050	1820

ACTRON 255 DG S M/G

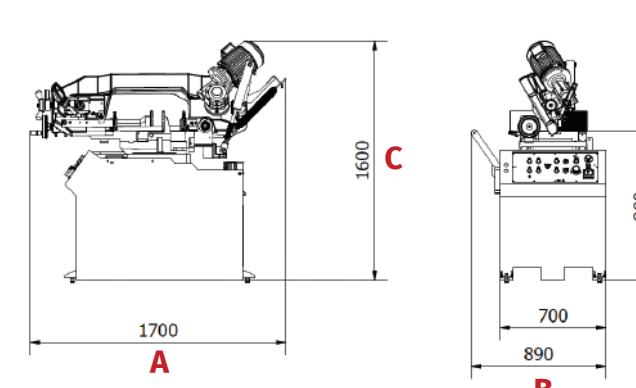

mm	2750x27x0,9
m³/min	20 - 80
kW	1,5
kg	540

°	0°	45°	60°	-45°
mm	255	185	115	180
mm	255	180	115	170
mm	H160x310	H230x170	H160x115	H220x140

A	B	C
1700	890	1600

ACTRON 460 DG S

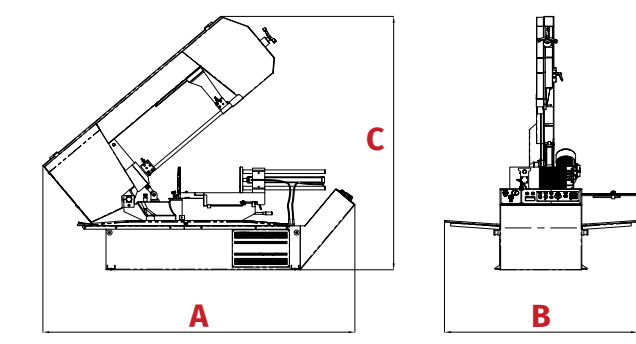

mm	2450x27x0,9
m³/min	35/71
kW	0,75-1,1
kg	260 270

°	0°	45°	60°	-45°	-60°
mm	460	450	240	450	300
mm	450	430	300	410	300
mm	H450x620	H400x450	H220x320	H340x450	H270x420

A	B	C
3050	800	2490

BITRON K3 S

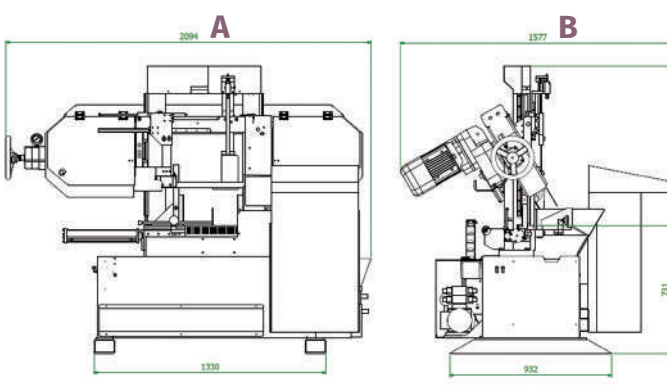

mm	3950x34
m³/min	20 - 100
kW	3
kg	850

°	0°
mm	300
mm	300
mm	H300x300

A	B	C
2100	1580	1650

BITRON K3D CUT S

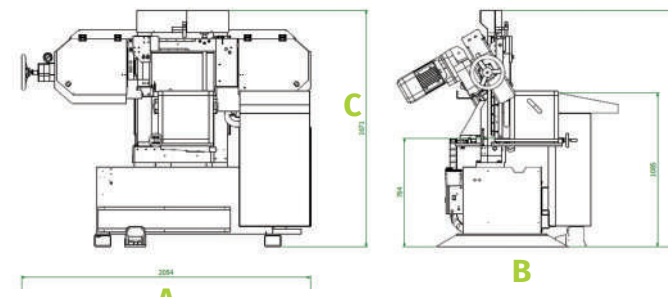

mm	3950x34
m³/min	20 - 100
kW	3
kg	950

°	0°
mm	300x500x300

A	B	C
1666	1963	1554